

Benex[®]
Pat.No. CH 696 458



Dr. Courier, Paris / France

“At the very beginning we thought, that it's a system which does not deserve much attention. But as time progressed with successful extractions, the simplicity of usage and extraction, the preservation of bone structures, the positive feedback from patients (one patient asked to extract another root with the Benex – this shows how pleased he was) – I have been convinced of the opposite.

In fact the system is absolutely not about knickknacks, but an elegant extraction system which helps to prevent in a number of cases an alveolectomy.”



We did not reinvent the wheel –
but we newly redefined extraction

Benex[®]
Pat.No. CH 696 458

3



We do not tell stories –

we will give you an insight, how an idea transforms into a product innovation

4

Sometimes you have to think in different dimensions so that a simple idea transforms into a sensation. Initially there is nothing which indicates that a new extraction system for the modern dentistry is under development.

NSI



Ideas without fail –

the idea of Dr. med., med. dent.
Benno Syfrig



5

A defective engine which had to be exchanged and a dentist sitting in front of it removing the shaft from the bearing. It is a typical job for a tinkerer like Benno Syfrig – a job to make him thought.

But what do tooth extraction and removing a shaft from a bear have in common? Do you have to think in a different way?

The answer: mechanics and biology in line.

But how does this interaction work?



Mechanics To remove the shaft from the bearing Benno Syfrig uses a tackle

Biology In the era of implantology the preservation of soft tissue is of great importance

The engine was removed without damaging surrounding components and with the help of the tackle. Is it possible to extract a tooth without damaging surrounding structures? Is there an instrument available on the market? If not, could this idea be realised? How should this instrument look like?

Coincidences are anticipated incidents which have a meaning –

6

the idea and the coincidence

Autumn 2003, St. Gallen / Switzerland

A regular dental congress day for the company Helmut Zepf. So it seems, until Dr. med., med. dent Benno Syfrig and Helmut Zepf meet personally. A meeting which affects the extraction procedure in such a way that nothing will ever be the same again. Benno Syfrig and Helmut Zepf are quick to agree that they will pursue this new path together.

A team consisting of Dr. med., med. dent Benno Syfrig, Helmut Zepf and the construction department. A meeting that calls into question everything so far existing for extraction in order to achieve the desired result "Benex". Suitable materials are sought and tested. Tinkering, trying, designing and discussing until the clinical testing and trial. A period which takes 365 days in order to ensure that everything is developed and designed in a way that both patient and dentist benefit likewise.

March 2005, Cologne / Germany

The Benex extraction system is launched during the IDS, the world's biggest dental show.

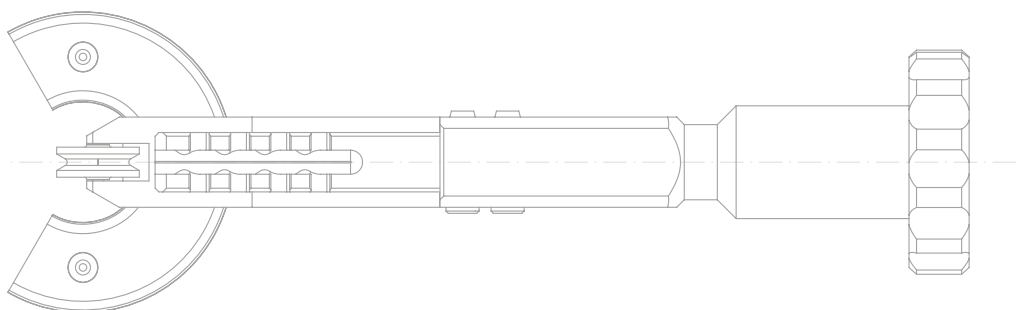

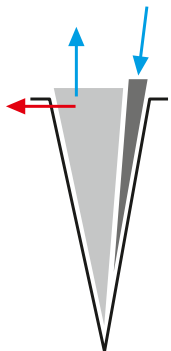
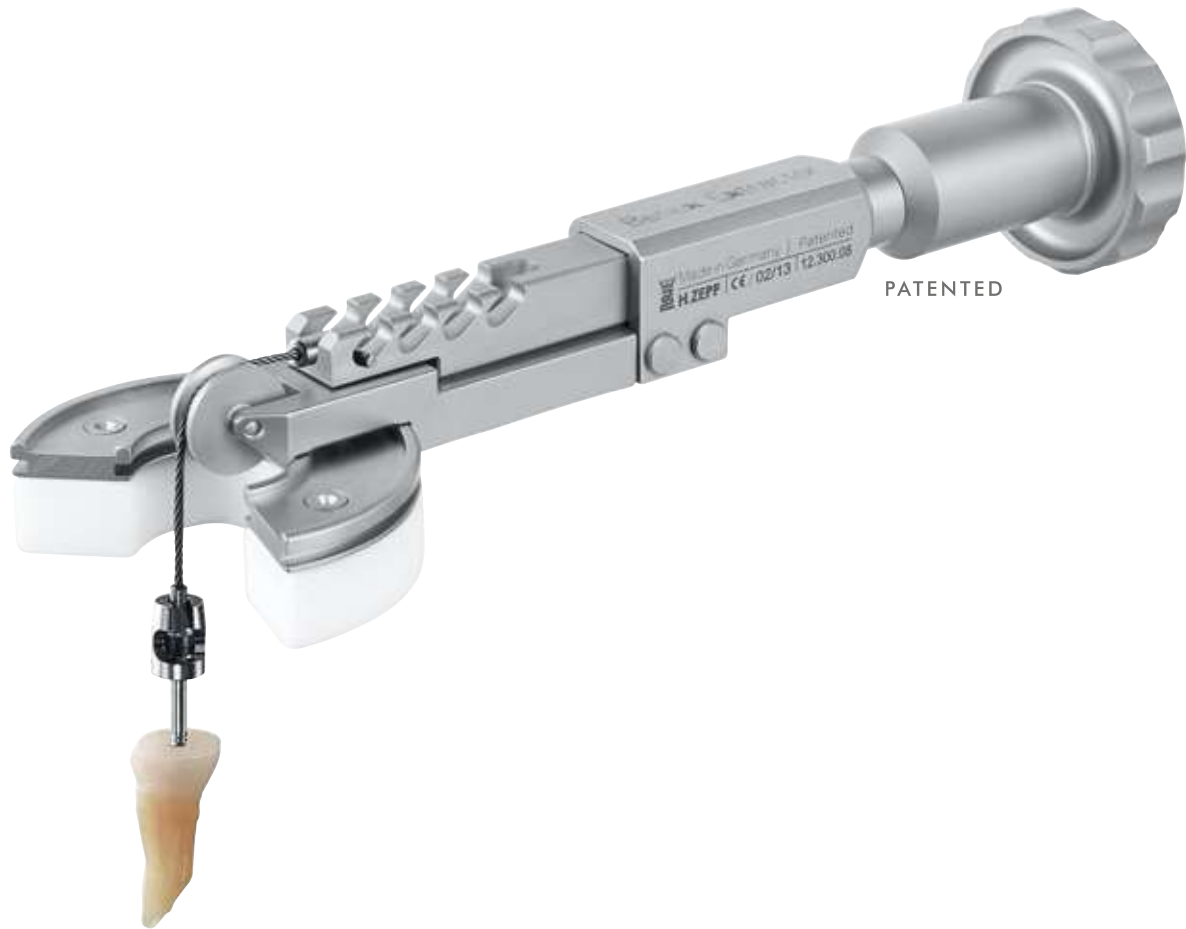

Polygon of forces, conventional

Pressure on the alveolar wall by forceps or root elevator

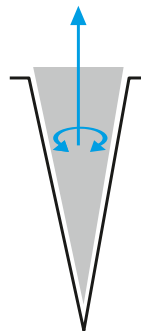

Polygon of forces with Benex[®] II

Purely axial traction



We do not want the world to become silent – as even one voice is powerful!

Benex statements from all over the world

9

Dr. Dietmar Weng, Starnberg / Germany

“If the buccal hard and soft tissue structures of the tooth socket must not be affected in the aesthetical critical region, the Benex Extraction System is a scarcely beatable tooth extraction tool as far as atraumatic extraction is concerned.”

Dr. Paulo Fernando M. de Carvalho, São Paulo / Brazil

“I’ve known the Benex System for 8 years and since then it has become an indispensable item in our surgical set: both in private practice and in our courses.

This innovative device allows a significant reduction of the trauma of hard/soft tissues and a decreasing surgical time, which are undoubted benefits to implantology at current time.”

PD, Dr. Dr. Michael Stiller, Berlin / Germany

„The gentle and minimally invasive extraction with the Benex Extraction System is a huge pre-implantological help in order to preserve soft tissue as well as the tooth socket for the following implant.“

Dr. Claudio Cacaci, Munich / Germany

“Due to its purely axial application, the Benex Extractor helps to protect the bone as well as the soft tissue. In this way, optimal conditions are created for a subsequently following implantation.”

Dr. Junichiro Maeda, Japan

“The Benex Extraction System is a must for the extraction and the immediate implant placement, as surrounding structures and the tooth socket are preserved. During an extraction there is always the risk of a damaged buccal wall or a damaged alveolar ridge which results in a lot of restoration work. With the Benex Extracton System it is possible to carry out an extraction in the shortest time without damaging bone or soft tissue structures, which also reduces the tension of patient and dentist equally.”

Dr. Holmes Ortega, Madrid / Spain

“When using the Benex Extraction System the risk of fracture of the buccal wall is considerably reduced. The Benex Extraction System is an important tool for all specialists in order to preserve bone structures, but above all it is also very good for dentists with still little experience, as it facilitates the extraction and minimizes the risk of a trauma.”

Prof. Dr. Gabriel Krastl, University Würzburg / Germany

“The Benex provides new opportunities within the surgical extrusion of deeply damaged teeth. Evidence has been provided that by using vertical extrusion equipment the probability of viability for the cementoblasts on the root surface is significantly higher than when using an extraction forceps while rotating the root. The vitality of these cells has a decisive influence on the fact whether the re-placed tooth will heal or ankylose.”



Case Study: Dr. Howard Gluckman –

Specialist in Periodontics, Implantology and
Oral Medicine

Director of Implant & Aesthetic Academy,
Cape Town / South Africa

10





Pre-op xray



Buccal view of the 14 and 15



Prepared root canals with the Benex diamond drills



Attachment in Place



Atraumatic extraction with no damage to the surrounding tissue



Provisional abutment in place



Lab provisionals in place



Buccal view after 10 days



Integration check 3 months post op showing excellent soft tissue healing



Final crowns showing excellent soft tissue

Case Study: Ryuboku Torikata D.D.S –

Director Ryuboku Dental Office
Osaka /Japan

12





Case Study: Prof. Dr. Thomas Dietrich
Dr. med., Dr. med. dent. MPH, FDSRCS –
Head of the Department of Oral Surgery in the
School of Dentistry
University of Birmingham / Great Britain

14





Extraction of an upper right second incisor in a 47 year old female (case no. 47):
Root to be extracted



Preparation of a slot after removal of caries



The impression tray with Silicon putty material is applied



Impression tray prepared for device application



Screw insertion using screw driver

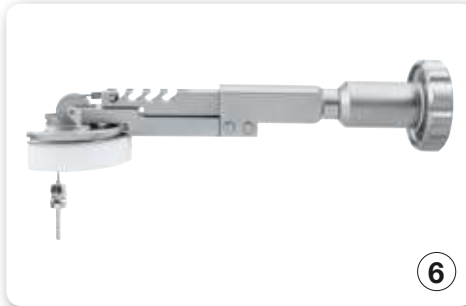

The Benex apparatus with the pullrope



Impression tray and Benex are applied, the pull-rope is hooked into the screw and axial alignment and robust support for the extractor is achieved



The tooth is extracted in a vertical direction



The extracted tooth



The socket after extraction



Case Study: Univ.- Prof. Dr. med. dent Dr. h.c. Georg-Hubertus Nentwig –

16

Chair of Oral Surgery and Implantology,
Specialist for Oral Surgery - Implantology
Frankfurt am Main / Germany





1
Documentation: Implant consultation trauma of the anterior teeth. The preservation of the teeth 12 and 11 was not possible due to the subcrestal fracture line (5 mm palatal).



2
After loosening the periodontal ligaments with a periosteal elevator, the trephined teeth are prepared for the Benex Screw with the Benex drill.



3
Due to the self-tapping thread of the screw it is very easy to fix it in the root canal.



4
A slow rotation of the knurled screw of the extractor will cause a rupture of the periodontal fibers which will be indicated by a drop of blood on the marginal seam.



5
The examination of the extraction wound shows an intact alveolar bone structure and it offers excellent conditions for the immediate implantation.



6
After a careful preparation of the implant site the implant can be placed with primary stability and a temporary restoration can follow.



7

Case Study: Robert Da Silva, Paulo Fernando Carvalho, Julio Joly –

18

implantperio
São Paulo / Brazil





Case Study: Dr. Dean Licenblat –

Director Sydney Dental Aesthetics & Implants
Bdent (USyd),
MSc (Oral Implantology) Goethe, DICOI
Sydney / Australia

20





Pre-op, cracked root and failed RCT



Decoronation



Benex Drill



Fixation of Benex Removal Post



Benex Extraction in progress!



Removed root
(total extraction time 2 mins 40 sec)



Perfectly preserved socket architecture with minimal to no bone damage or soft tissue mutilation



Cover Screw placed



Dense Collagen Plug attached to Membrane Screw to act as socket & GBR protection



Case complete – everything as predicted as Benex allowed preservation of site



Case Study: Dr. Juanjo Iturralde –

Specialist Periodontics,
Implantology and Aesthetic dentistry
Director Clínica dental Iturralde
Tafalla (Navarra) / Spain

22





Pre treatment



Screw placement



Extracted root



View of the alveole



3d positioning of the implant



Temporary crown



Positioning of the transplant



Conservation of soft tissue



Final crown



View of the obtained soft tissue



Extrusion as a logical consequence of extraction –

24

a very easy method for crown lengthening with
the Benex Extractor

In an interview, Dr. Syfrig describes his current experience with Benex Extrusion.

You have invented the forced extrusion with the Benex System?

Syfrig: No. The extrusion is not an invention.
It is the logical consequence of a tissue-conserving Benex extraction.

How is that to be understood?

Syfrig: More than 10 years ago, I developed the Benex Extraction System with the company Zepf.
Among experts, this was considered as invention and was patented.

**This means that extrusion with Benex is not an invention, but
you were the first to apply this treatment method?**

Syfrig: Yes. For the simple reason that I am working with the Benex for the longest time.

What do you mean by that?

Syfrig: I am working as an oral surgeon, and frequent medical referral forms read: "Hopeless tooth – for extraction and implantation". For years, I have extracted such teeth in a gentle way with Benex and replaced them with an implant.
I often regretted to throw away preserved root parts.

Finally, on November 24th, 2009 I interrupted the Benex extraction of a so-called hopeless tooth for the first time,
and I splinted the root, extruded by 4 mm, to the adjacent tooth.
What was to be expected, happened: The periradicular soft and hard tissue healed within some weeks.
The tooth could be built up and conserved with synthetic material.

The periradicular tissue healed within some weeks?

Syfrig: Yes. All cases showed a healed gingiva after 3 weeks, and signs of apical reossification were found after 3 weeks.
From the radiological point of view, a restitutio ad integrum is found after 12 weeks, and the periodontal space is
inconspicuous from the periradicular point of view.

How often do you perform extrusion treatments?

Syfrig: Up to now, I performed Benex extrusion treatments in 52 cases, exclusively on teeth with an indication of
imperative extraction. These treatments are increasing every year, and the potential is still not yet exhausted.

What do you think: In how many cases can an extrusion treatment substitute an extraction?

Syfrig: I suppose that 10% of single-rooted teeth can be extruded and conserved instead of extracted.

**In transplantations and replantations, usually antiresorptive and regenerative medication like antibiotics and
corticoids are administered. What kind of medication do you administer during an extrusion treatment?**

Syfrig: I instruct the patients to rinse with chlorhexidine for a period of 10 days.
The need for pain medication is usually low. Other medication is not required.





After the preparation of root posts, the Benex screw was inserted and the Benex extractor was positioned.



The extruded root is fixed with wooden wedges and then the Benex screw is removed.



The canal pin is cemented.



A crown temporary is prepared with synthetic material and fixed with the help of the neighboring teeth.



Three months after extrusion, the final crown restoration is performed.

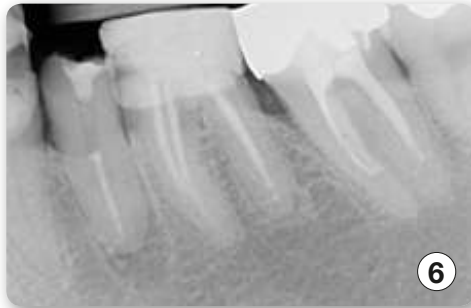

The first patient case, solved by extrusion. Radiological control immediately upon extrusion.



The situation 14 weeks after extrusion (7)
4 1/2 years after extrusion (8)



Hockey player with front teeth trauma.



3 weeks after extrusion, the temporary plastic splint was removed.



This is how the patient plays ice hockey today!







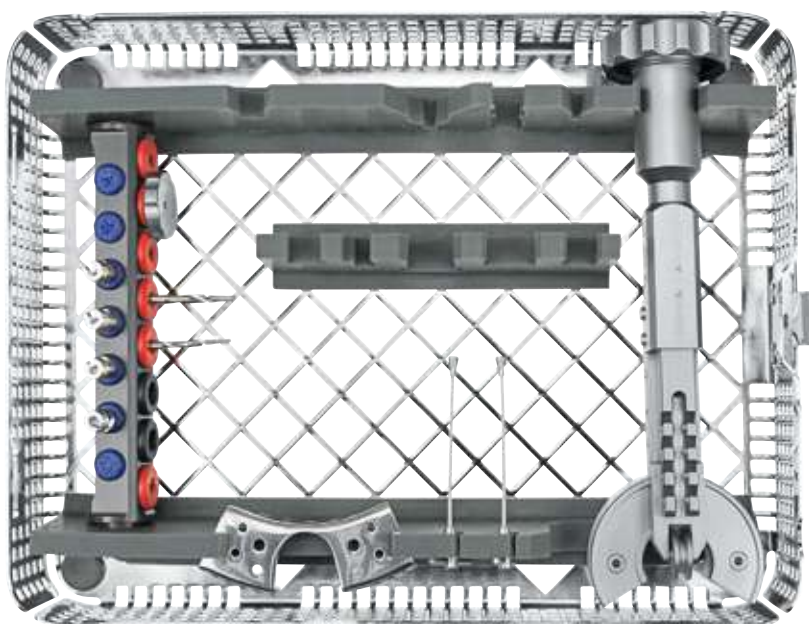

Benex® II Basic Kit

Pat.No. CH 696 458

26







Optional Accessories

Illustration	Article Description	Order Quantity
	<p>12.300.15</p> <p>Replacement Support Disc, 8 mm (PTFE)</p>	<p>1 piece</p>
	<p>12.300.16</p> <p>Support Disc, diagonally right</p>	<p>1 piece</p>
	<p>12.300.17</p> <p>Support Disc, diagonally left</p>	<p>1 piece</p>
	<p>12.300.11</p> <p>Benex® Pole Extractor</p>	<p>1 piece</p>
	<p>47.525.55</p> <p>Ratchet with demountable handle</p>	<p>1 piece</p>
	<p>47.525.50</p> <p>Driver Guide FD</p>	<p>1 piece</p>
	<p>12.300.45</p> <p>Benex® Blade for Driver Guide FD</p>	<p>1 piece</p>

Content **Benex II** Basic Kit

Illustration

Illustration	Article Description	Order Quantity
	12.303.00 Benex II Basic Kit consisting of: Extractor, 2 Pullropes 48 mm, Driver Guide, Screw short 1.6 mm + 2.1 mm, Screw long 1.6 mm + 2.1 mm, 1 Drill ea. for 1.6 mm + 2.1 mm Screws, Quadrant Support, Washbasket 1/2 with Lid 85.194.10	1 set
	85.194.10 Washbasket 1/2 with Lid and Press Button Lock	1 piece
	12.300.08 Benex II Extractor	1 piece
	12.300.20 Pullrope, 48 mm	2 pieces
	12.300.30 Diamond coated Drill for Screws Ø 1,6 mm 12.300.60 and 12.300.70	2 pieces 1 piece in set
	12.300.35 Diamond coated Drill for Screws Ø 2,1 mm 12.300.65 and 12.300.75	2 pieces 1 piece in set
	12.300.47 Driver Guide, short	1 piece
	12.300.60 Screw, Ø 1,6 mm, 10 mm, S = Short	2 pieces 1 piece in set
	12.300.65 Screw, Ø 2,1 mm, 10 mm, SF = Short & Fat	2 pieces 1 piece in set
	12.300.70 Screw, Ø 1,6 mm, 16 mm, L = Long	2 pieces 1 piece in set
	12.300.75 Screw, Ø 2,1 mm, 16 mm, LF = Long & Fat	2 pieces 1 piece in set
	12.300.80 Quadrant Support for Benex II to bridgeover bigger gaps and for the universal molding	1 piece







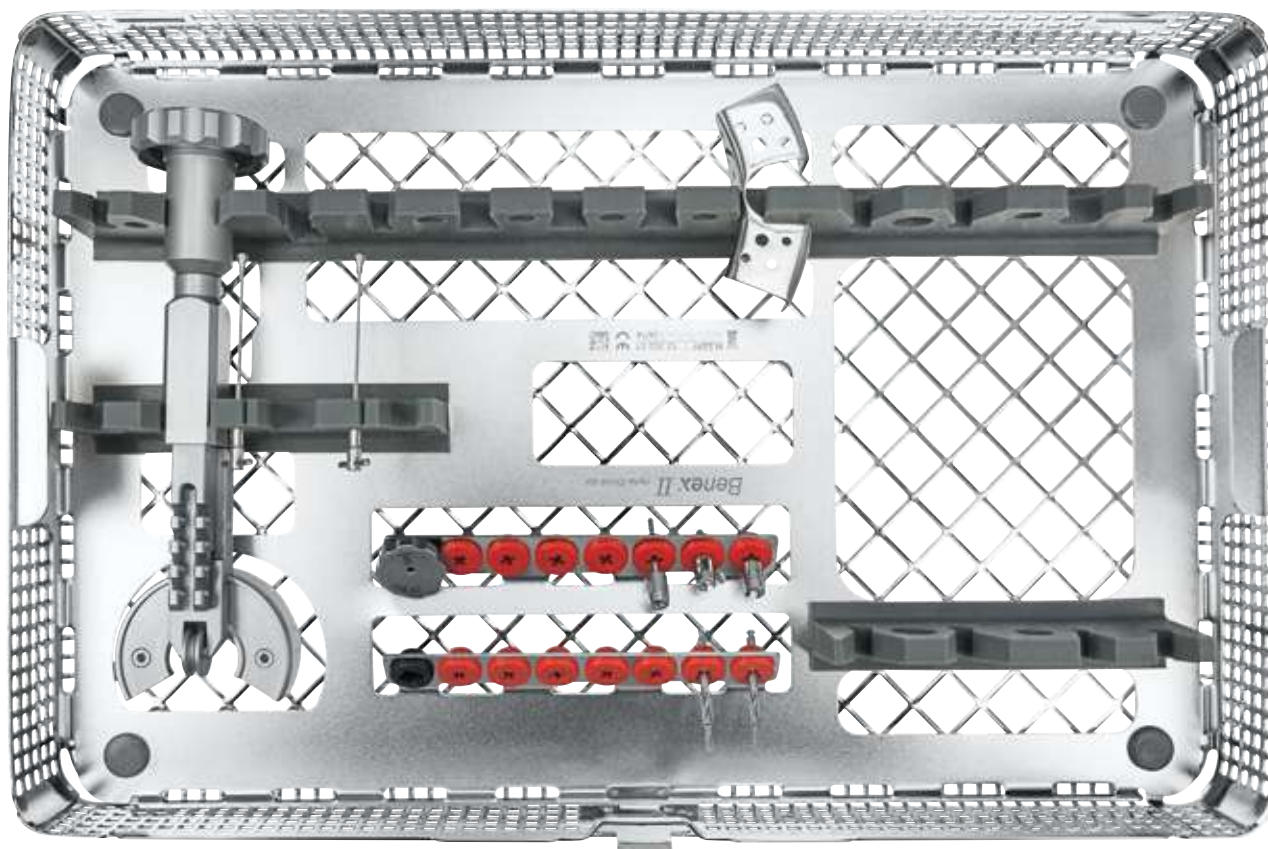

Benex® II Extraction System

Pat.No. CH 696 458

28













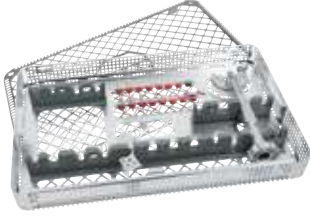

Optional Accessories

Illustration	Article Description	Order Quantity
	12.300.15 Replacement Support Disc, 8 mm (PTFE)	1 piece
	12.300.16 Support Disc, diagonally right	1 piece
	12.300.17 Support Disc, diagonally left	1 piece
	12.300.11 Benex® Pole Extractor	1 piece
	47.525.55 Ratchet with demountable handle	1 piece
	47.525.50 Driver Guide FD	1 piece
	12.300.45 Benex® Blade for Driver Guide FD	1 piece

Illustration

Article Description

Order Quantity

	<p>12.302.00</p> <p>Benex[®] II Extraction System consisting of: Extractor, 2 Pullropes 48 mm, Driver Guide, Screw short 1.6 mm + 2.1 mm, Screw long 1.6 mm, 1 Drill ea. for 1.6 mm, 2.1 mm Screws, Quadrant Support, Washbasket 1/1 with Lid 85.195.10, 12.302.01 Tray / Rack for Benex[®] II</p>	<p>1 set</p>
	<p>12.302.01</p> <p>Benex[®] II Tray / Rack</p>	<p>1 piece</p>
	<p>85.195.10</p> <p>Washtray 1/1 with Lid and Press Button Lock</p>	<p>1 piece</p>
	<p>12.300.08</p> <p>Benex[®] II Extractor</p>	<p>1 piece</p>
	<p>12.300.20</p> <p>Pullrope, 48 mm</p>	<p>2 pieces</p>
	<p>12.300.30</p> <p>Diamond coated Drill for Screws Ø 1.6 mm 12.300.60 and 12.300.70</p>	<p>2 pieces 1 piece in set</p>
	<p>12.300.35</p> <p>Diamond coated Drill for Screws Ø 2.1 mm 12.300.65 and 12.300.75</p>	<p>2 pieces 1 piece in set</p>
	<p>12.300.47</p> <p>Driver Guide, short</p>	<p>1 piece</p>
	<p>12.300.60</p> <p>Screw, Ø 1.6 mm, 10 mm, S = Short</p>	<p>2 pieces 1 piece in set</p>
	<p>12.300.65</p> <p>Screw, Ø 2.1 mm, 10 mm, SF = Short & Fat</p>	<p>2 pieces 1 piece in set</p>
	<p>12.300.70</p> <p>Screw, Ø 1.6 mm, 16 mm, L = Long</p>	<p>2 pieces 1 piece in set</p>
	<p>12.300.75</p> <p>Screw, Ø 2.1 mm, 16 mm, LF = Long & Fat</p>	<p>2 pieces 1 piece in set</p>
	<p>12.300.80</p> <p>Quadrant Support for Benex[®] to bridgeover bigger gaps and for the universal molding</p>	<p>1 piece</p>



Made by history –

or a special request in 1921

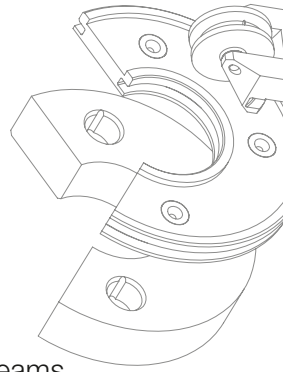

History shows that there are not invisible dreams...

1921, Seitingen / Germany

The demand for special surgical instruments is growing in line with the progress in medicine. Isidor Zepf and his wife Rosa who was the first female surgical instrument manufacturer recognize this development take the opportunity to set up their own company for the production of surgical instruments.

1922, Berlin / Germany

Dr. Ferdinand Sauerbruch, a surgeon from Berlin who is famous for several surgical techniques is struggling with his demand for special surgical instruments he is in need for. As a surgeon he has a clear-cut idea regarding quality and characteristic of the instruments he is looking for. It is not easy to meet his demand.



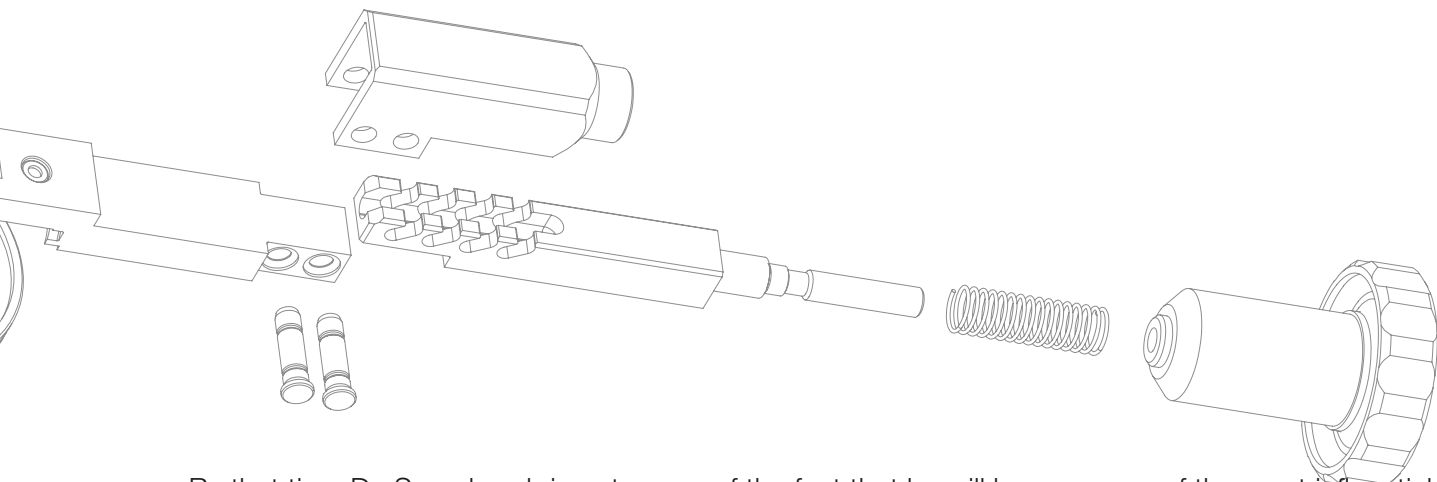

By that time Dr. Sauerbruch is not aware of the fact that he will become one of the most influential surgeons in the 20th century.

Does this event ring a bell?

Yes, it is very similar to the successful Benex development with Dr. Syfrig.

The well-known surgeon turns to Zepf who was back then a quite young company with new ideas and with the ability to make exactly the instrument Dr. Sauerbruch is in need for. Quality, function and design on a different level.

In 1930 Zepf increasingly specializes in manufacturing dental instruments and forms the foundation for the company we now are.

Rapidly implementing innovations in the field of medical instruments and working in close collaboration with well-known doctors is the key to our success.

Still managed by members of the Zepf family we found our own way to maintain our position regarding quality, competition and the urge to develop new ideas which will become not only product but a solution to a problem. However, we will never lose our focus on our demand for high quality and the commitment towards doctors and patients.

And sometimes we have to go a different way from what seems to be the safe way – just because we are brave enough to try something new:

Why?

That's simple – BECAUSE WE ARE ZEPF!



When will you tell us about your
Benex experience?

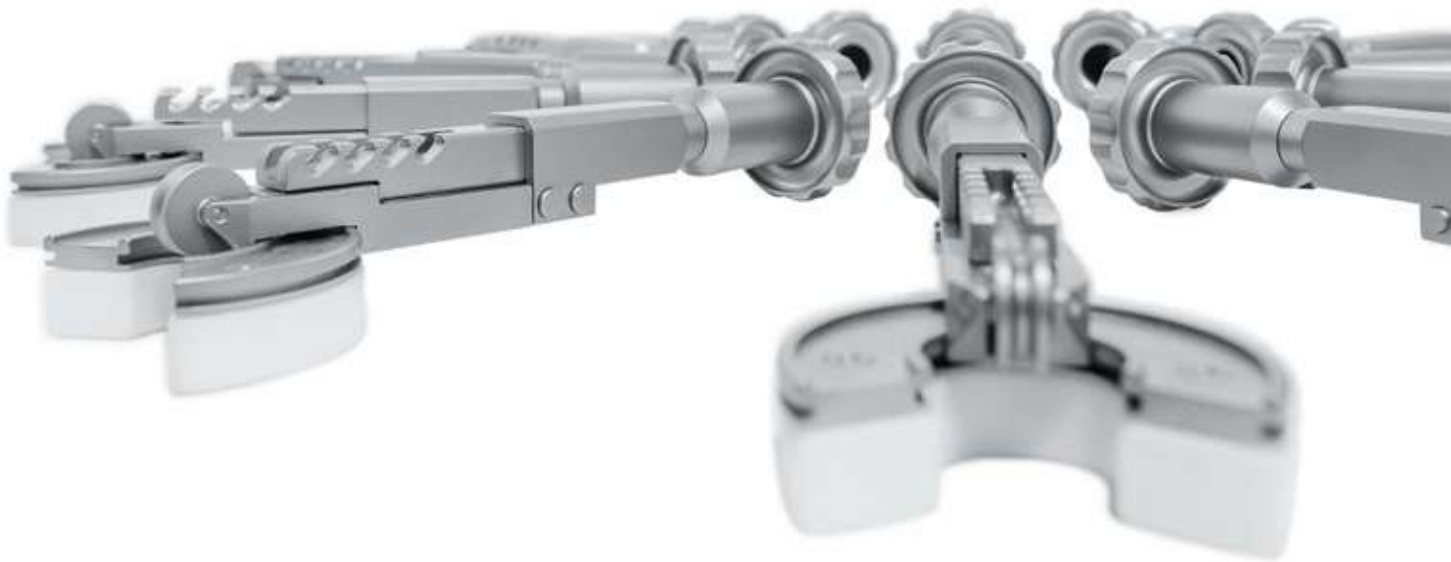

AESTHETIC IS THE RESULT



HELMUT ZEPF MEDIZINTECHNIK GMBH · FACTORY FOR DENTAL & SURGICAL INSTRUMENTS
Obere Hauptstr. 16-22 · 78606 Seitingen-Oberflacht, Germany
Tel.: +49 (0) 74 64 / 98 88 -0 · Fax: +49 (0) 74 64 / 98 88 -88 · zepf-dental.com

MADE  IN GERMANY